













ANTENNAS | SWIRL SERIES

X-POLARISED, OMNI-DIRECTIONAL 5G/LTE MULTI MIMO ANTENNA ARRAY

617 – 6000 MHz, 6dBi; Cellular 8x8 MIMO; Wi-Fi 4x4 MIMO; 1 x GNSS



 617 – 960 MHz 1427 – 1517 MHz 1710 – 2700 MHz 3400 – 6000 MHz	 6dBi	 3.5 GHz CBRS	 Omni-Directional	 5G	 BAND 71 617 – 698 MHz
 4x4 MIMO OR 8x8 MIMO	 2.4 – 2.5 GHz 5.0 – 7.2 GHz	 GNSS Included	 -40°C to +80°C	 IP69K	 E-Mark Certified



APPLICATION AREAS

- High performance, omni-directional marine & coastal antenna
- Up to 8 x 8 MIMO cellular capability for improved performance
- Covers contemporary 5G/LTE band from 617 to 6000 MHz
- Innovative heat sink design for improved temperature regulation
- E-Mark certified ensuring compliance, safety, and performance in automotive applications
- UV and saltwater protected for marine and coastal conditions
- IP 69K weather/dust resistant enclosure

Product Overview

Poynting Antennas proudly introduces the SWIRL antenna solution, designed for both maritime and mobility applications. The SWIRL series includes two versatile models: the SWIRL-8 and the SWIRL-4. The SWIRL-8 features 8x cross-polarised cellular antennas, covering frequencies from 617 to 6000 MHz with a peak gain of 6dBi, 4x dual-band Wi-Fi antennas (2.4 GHz and 5 to 7.2 GHz), and 1x dual-band GNSS antenna for L1 and L5 constellations. The SWIRL-4 offers 4x cross-polarised cellular antennas, 2x dual-band Wi-Fi antennas, and 1x dual-band GNSS antenna.

The SWIRL antenna boasts a compact design, measuring 382 mm in diameter and 127 mm in height. It has IK08 and IP69K ratings, ensuring durability in harsh environments. While the SWIRL is primarily aimed at maritime applications, it is also suitable for various other applications, such as mobility and fixed wireless access (FWA), making it a highly adaptable choice for diverse connectivity needs.

Experience the future of connectivity with Poynting's SWIRL antenna solution, engineered for seamless integration and superior performance in demanding environments.

Features

- Wide Frequency Range: Cellular antennas (617 to 6000 MHz) and dual-band Wi-Fi (2.4 GHz and 5 to 7.2 GHz).
- High Gain Performance with a peak gain of 6dBi for robust signal strength.
- Durable Construction: IK08 and IP69K ratings for protection against impacts and environmental factors.
- CPE Transformation: Compatible with SWIRL-BASE for integrating 5G routers, enhancing performance with short coaxial cable run

Application Areas

- Reliable connectivity for ships, boats, and other marine vessels.
- Enhanced network performance for vehicles and other mobile platforms.
- Stable connections for remote sites and infrastructure monitoring.
- Robust communication systems for emergency response and public safety services.
- Efficient data transmission for various Internet of Things (IoT) applications in challenging environments.

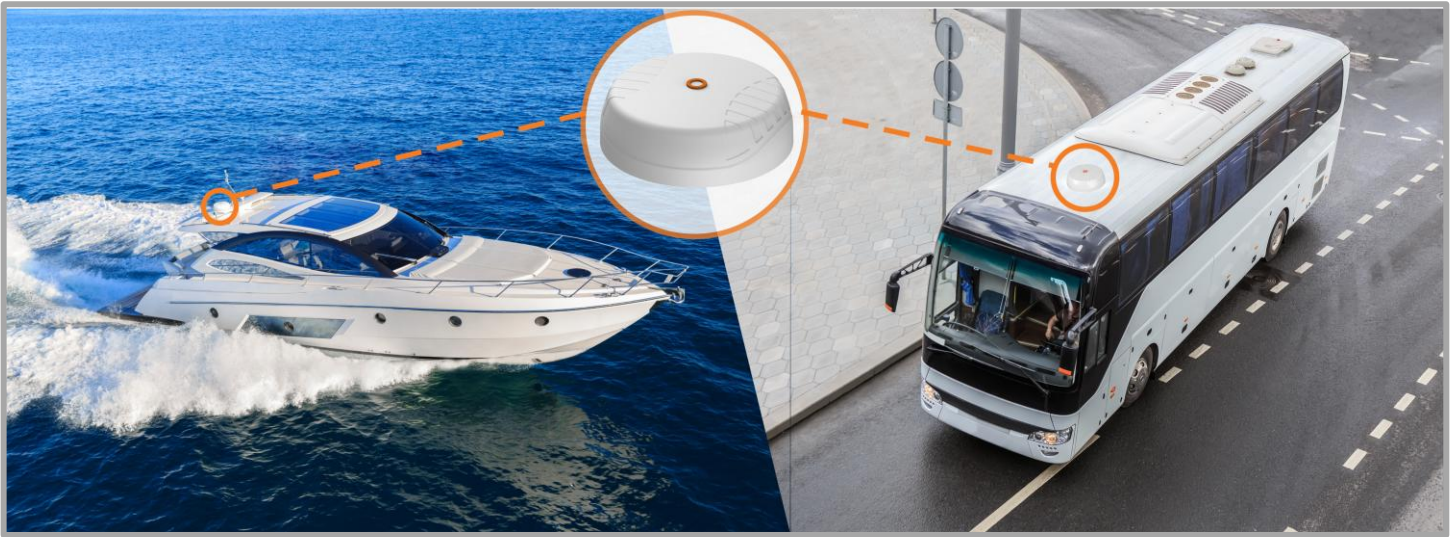

Frequency Bands

The SWIRL is an omni-directional antenna array that operates in the following frequency bands: | 617 – 960 MHz | 1427 – 1517 MHz | 1710 – 2700 MHz | 3400 – 4200 MHz | 5000 – 6000 MHz | and the following Wi-Fi frequency bands | 2400 – 2500 MHz | and | 5000 – 7200 MHz |

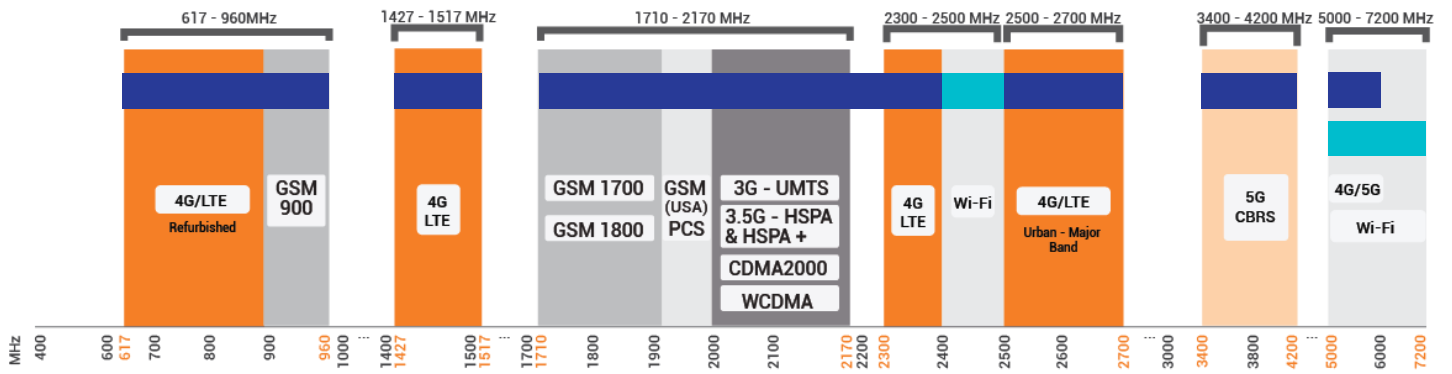

Indicates the 5G/LTE bands on which SWIRL works Indicates the WI-FI bands on which SWIRL works

Antenna Derivatives

Product Order Code (SKU)	A-SWIRL-0004-V1-01	A-SWIRL-0008-V1-01
Ports	5G- Vertical Polarised (x 2), 5G- Horizontal Polarised (x 2) Wi-Fi- Vertical Polarised (x 1), Wi-Fi- Horizontal Polarised (x 1) GNSS (x 1)	5G- Vertical Polarised (x 4), 5G- Horizontal Polarised (x 4) Wi-Fi- Vertical Polarised (x 2), Wi-Fi- Horizontal Polarised (x 2) GNSS (x 1)
SISO / MIMO	4x4 MIMO- 5G 2x2 MIMO – Wi-Fi	8x8 MIMO- 5G 4x4 MIMO – Wi-Fi
Frequency Bands	617 - 6000 MHz	617 - 6000 MHz
Polarisation	Vertical & Horizontal	Vertical & Horizontal
Peak Gain	6dBi	6dBi
Connector Type	4 x RTK-031 (SMA-M to SMA-M): Cellular 2 x RTK-031 (RP-SMA-M to RP-SMA-M): Wi-Fi 1 x RTK-031 (SMA-M to SMA-F): GPS	8 x RTK-031 (SMA-M to SMA-M): Cellular 4 x RTK-031 (RP-SMA-M to RP-SMA-M): Wi-Fi 1 x RTK-031 (SMA-M to SMA-F): GPS
Coax Cable Type	7 x RTK-031	13 x RTK-031
Coax Cable Length	650 mm – 5G, Wi-Fi & GPS	650 mm – 5G, Wi-Fi & GPS
Product Dimensions	Ø382 x 127 mm	Ø382 x 127 mm
Packaged Dimension	450 x 450 x 180 mm	450 x 450 x 180 mm
Weight	2.45 Kg	2.55 Kg
Packaged Weight	4.15 Kg	4.25 Kg
EAN	6009710928578	6009710928639
E-Mark Certification Number	E1*10R06/03*10530*00	E1*10R06/03*10530*00

Electrical Specifications - Cellular

Frequency Bands:	617 – 960 MHz 1427 – 1517 MHz 1710 – 2700 MHz 3400 – 4200 MHz 5000 – 6000 MHz
Gain Vertical:	4 dBi @ 617 – 960 MHz 4 dBi @ 1427 – 1517 MHz 6 dBi @ 1710 – 2700 MHz 5.5 dBi @ 3400 – 4200 MHz 4 dBi @ 5000 – 6000 MHz
Gain Horizontal:	2 dBi @ 617 – 960 MHz 2 dBi @ 1427 – 1517 MHz 4 dBi @ 1710 – 2700 MHz 2 dBi @ 3400 – 4200 MHz 4 dBi @ 5000 – 6000 MHz
VSWR Vertical:	≤2.5:1
VSWR Horizontal:	≤2.5:1
Feed Power Handling:	10 W
Input Impedance:	50 Ohm (nominal)
DC Short:	Yes

Electrical Specifications - GNSS

Frequency Range (GPS):	GPS L5: 1176 MHz ± 20 MHz GPS L1: 1575 MHz ± 20 MHz
LNA Gain:	20 ± 2 dBi
VSWR:	≤2
DC Voltage:	2.7 – 5 V
DC Current:	<15 mA
Nominal Impedance:	50 Ω
Polarisation:	RHCP
Out of Band Rejection:	40dBc min
Coax Cable Loss:	0.71 dB/m @ 1500 MHz

Electrical Specifications - Wi-Fi

Frequency:	2400 - 2500 MHz 5000 – 7200 MHz
Gain (Max):	5 dBi @ 2400 - 2500 MHz 8.5 dBi @ 5000 - 7200 MHz
VSWR:	≤ 2.5:1 over 90% of the band
Feed Power Handling:	10 W
Nominal Input Impedance:	50 Ohm (nominal)
Coax Cable Loss:	0.91 dB/m @ 2400 MHz 1.65 dB/m @ 5800 MHz
Path to Ground:	Yes

Mechanical Specifications

Radome Material:	UV Stable ASA
Radome Colour:	Brilliant White Pantone P 179-1 C
Mounting Type:	Surface Mount and Optional Magnetic Mount

Environmental Specifications, Certification & Approvals

Wind Survival:	≤186 km/h
Temperature Range (Operating):	-40°C to +80°C
Environmental Conditions:	Outdoor/Indoor
Water ingress protection ratio/standard:	IP69K
Salt Spray:	MIL-STD 810G/ASTM B117
Operating Relative Humidity:	Up to 98%
Storage Humidity:	5% to 95% - non-condensing
Storage Temperature:	-40°C to +80°C
Enclosure Flammability Rating:	UL 94-HB
Impact resistance:	IK 08
Product Safety & Environmental:	Complies with CE and RoHS standards



Antenna Performance Plots

VSWR: Cellular Vertical

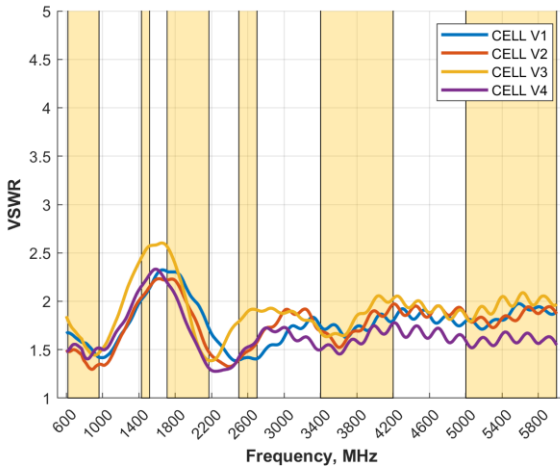

Voltage Standing Wave Ratio (VSWR)*

VSWR is a measure of how efficiently radio-frequency power is transmitted from a power source, through a transmission line, into a load. In an ideal system, 100% of the energy is transmitted which corresponds to a VSWR of 1:1.

The SWIRL delivers superior performance across all bands with a VSWR of $\leq 2.5:1$.

*VSWR measured with a 650mm low loss cable

GAIN (EXCLUDING CABLE LOSS): Cellular Vertical

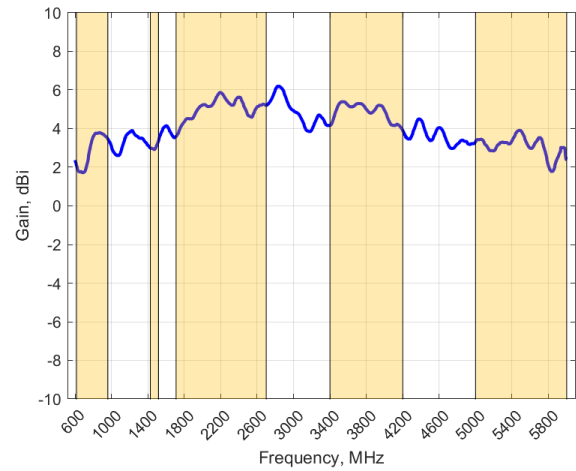

Gain* in dBi

6 dBi is the peak gain across all bands from 617 – 6000 MHz

Gain @ 617 – 960 MHz:	4 dBi
Gain @ 1427 – 1517 MHz:	4 dBi
Gain @ 1710 – 2700 MHz:	6 dBi
Gain @ 3400 – 4200 MHz:	5.5 dBi
Gain @ 5000 – 6000 MHz:	4 dBi

*Antenna gain measured with polarisation aligned standard antenna

VSWR: Cellular Horizontal

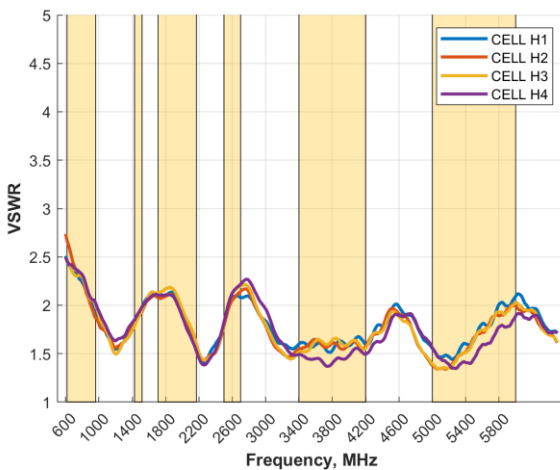

Voltage Standing Wave Ratio (VSWR)*

VSWR is a measure of how efficiently radio-frequency power is transmitted from a power source, through a transmission line, into a load. In an ideal system, 100% of the energy is transmitted which corresponds to a VSWR of 1:1.

The SWIRL delivers superior performance across all bands with a VSWR of $\leq 2.5:1$ or better.

*VSWR measured with a 650mm low loss cable

GAIN (EXCLUDING CABLE LOSS): Cellular Horizontal

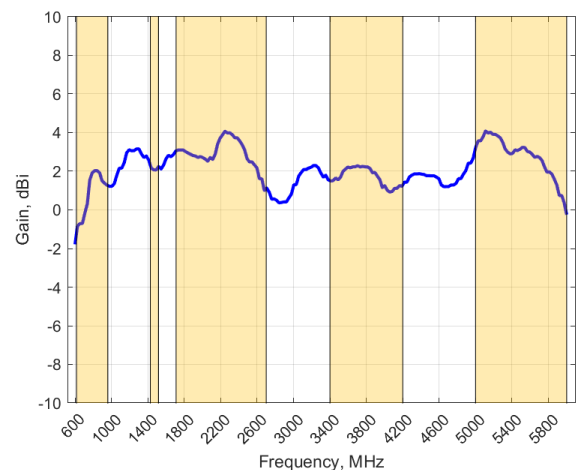

Gain* in dBi

4 dBi is the peak gain across all bands from 617 – 6000 MHz

Gain @ 617 – 960 MHz:	2 dBi
Gain @ 1427 – 1517 MHz:	2 dBi
Gain @ 1710 – 2700 MHz:	4 dBi
Gain @ 3400 – 4200 MHz:	2 dBi
Gain @ 5000 – 6000 MHz:	4 dBi

*Antenna gain measured with polarisation aligned standard antenna

VSWR: WI-FI

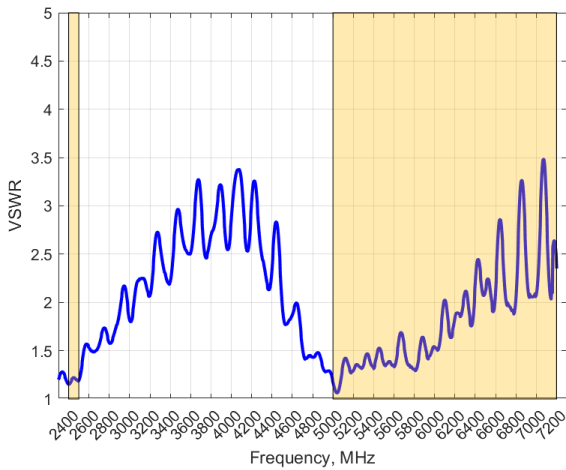

Voltage Standing Wave Ratio (VSWR)*

VSWR is a measure of how efficiently radio-frequency power is transmitted from a power source, through a transmission line, into a load. In an ideal system, 100% of the energy is transmitted which corresponds to a VSWR of 1:1.

The SWIRL delivers superior performance across all bands with a VSWR of $\leq 2.5:1$ across 90% of the bands.

*VSWR measured with a 650mm low loss cable.

GAIN (EXCLUDING CABLE LOSS): WI-FI

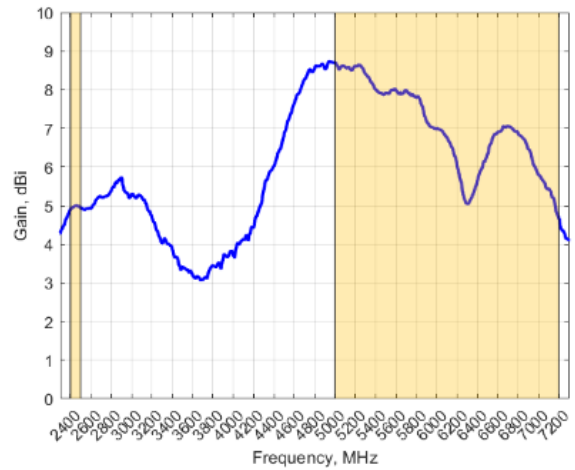

Gain* in dBi

8.5 dBi is the peak gain across all bands from 2400 – 7200 MHz

Gain @ 2400 – 2500 MHz:	5 dBi
Gain @ 5000 – 7200 MHz:	8.5 dBi

*Antenna gain measured with polarisation aligned standard antenna

ISOLATION: Cellular

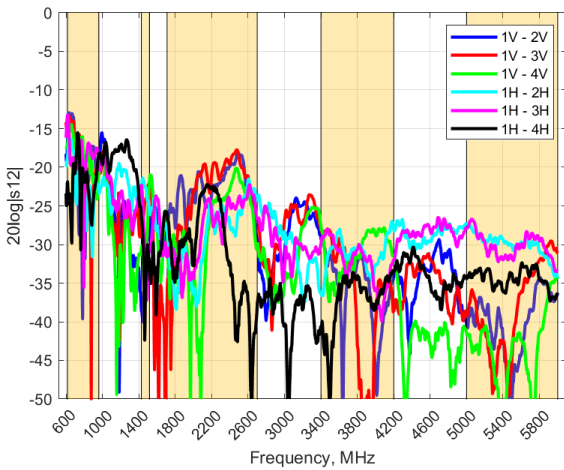

Isolation

Isolation is a measurement of the amount of energy leaked from one port to another. A good isolation is under -20 dB.

ISOLATION: Cellular

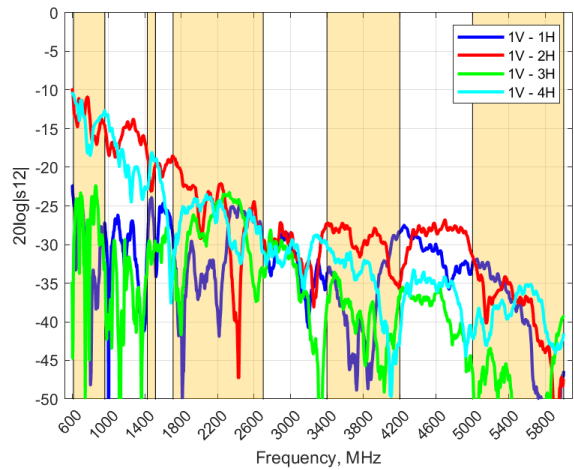

Isolation

Isolation is a measurement of the amount of energy leaked from one port to another. A good isolation is under -20 dB.

Radiation Patterns - Cellular Vertical

Azimuth: 617 – 960 MHz

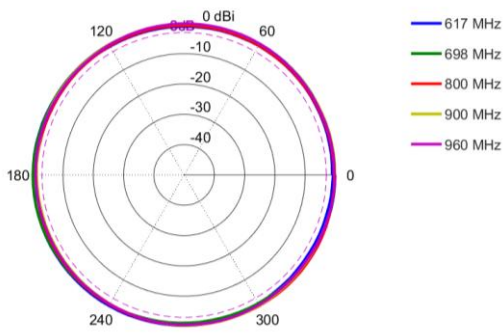

Elevation: 617 – 960 MHz

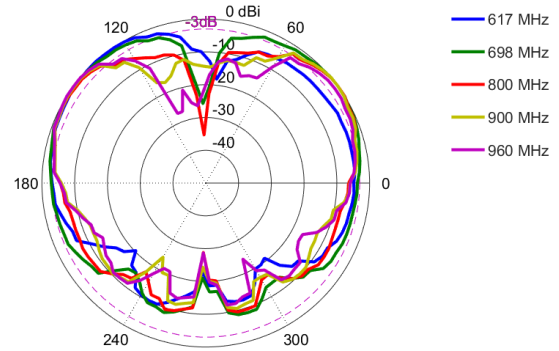

Azimuth: 1427 – 1517 MHz

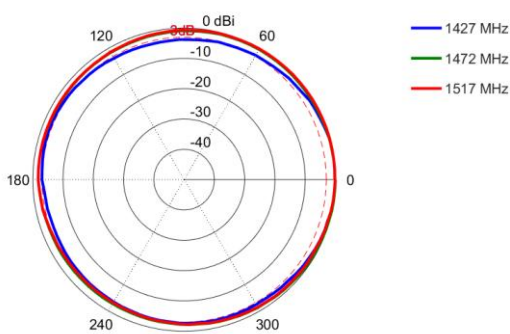

Elevation: 1427 – 1517 MHz

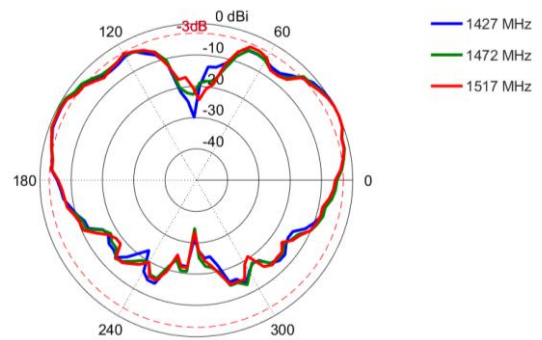

Azimuth: 1710 – 2170 MHz

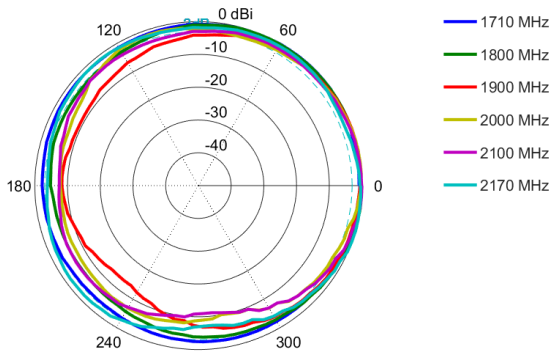

Elevation: 1710 – 2170 MHz

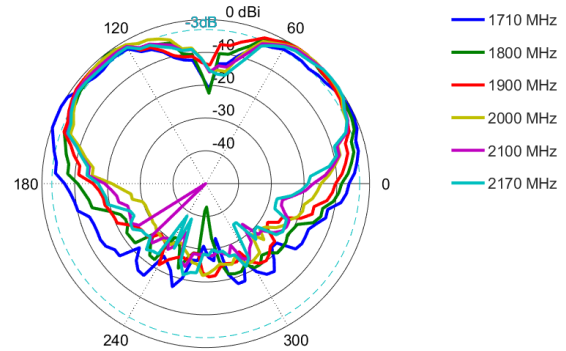

Azimuth: 2300 – 2700 MHz

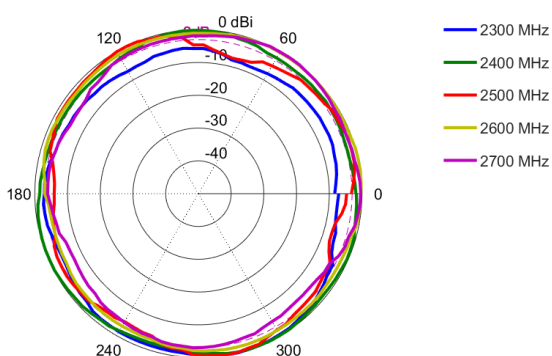

Elevation: 2300 – 2700 MHz

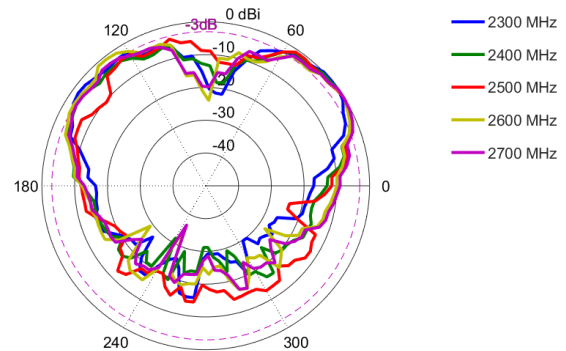

Azimuth: 3400 – 4200 MHz

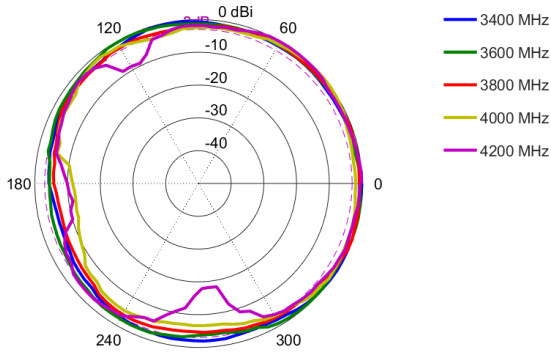

Elevation: 3400 – 4200 MHz

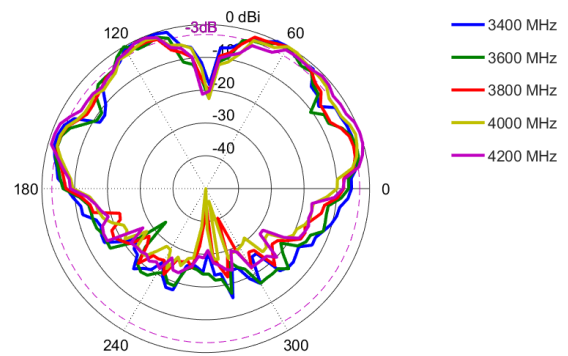

Azimuth: 5000 – 6000 MHz

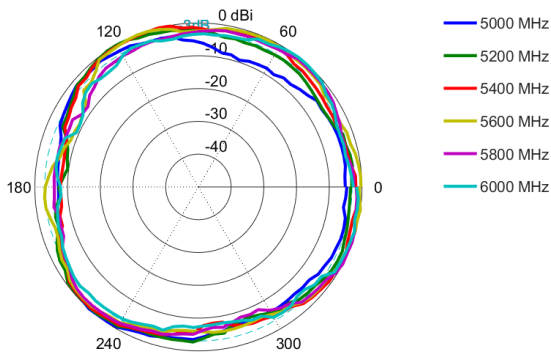

Elevation: 5000 – 6000 MHz

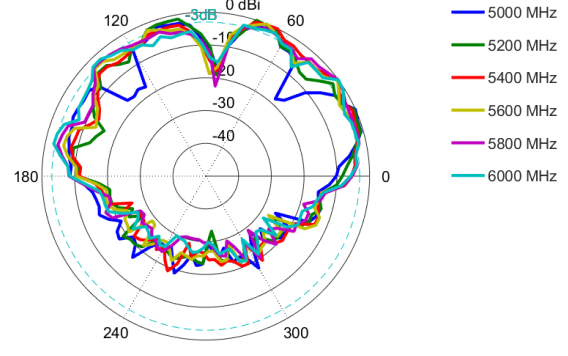

Radiation Patterns - Cellular Horizontal

Azimuth: 617 – 960 MHz

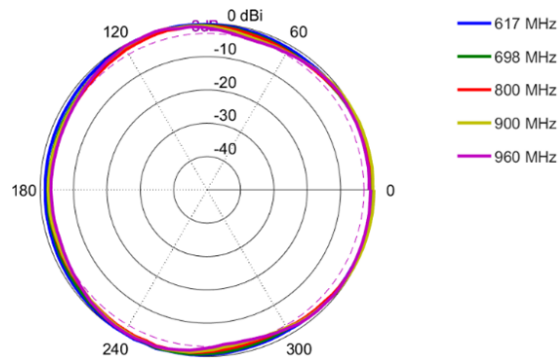

Elevation: 617 – 960 MHz

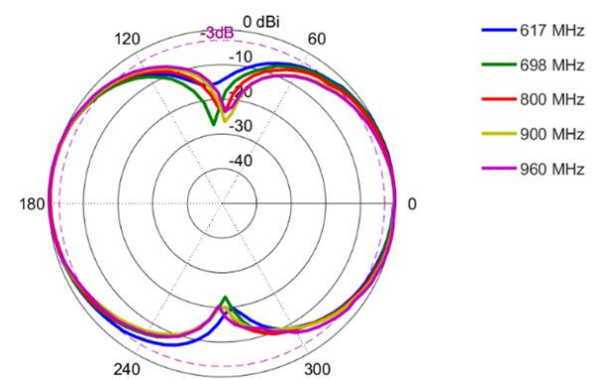

Azimuth: 1427 – 1517 MHz

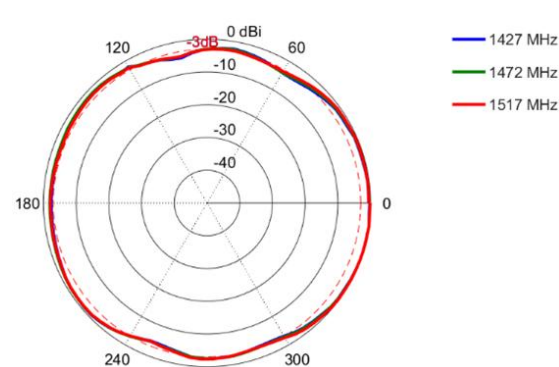

Elevation: 1427 – 1517 MHz

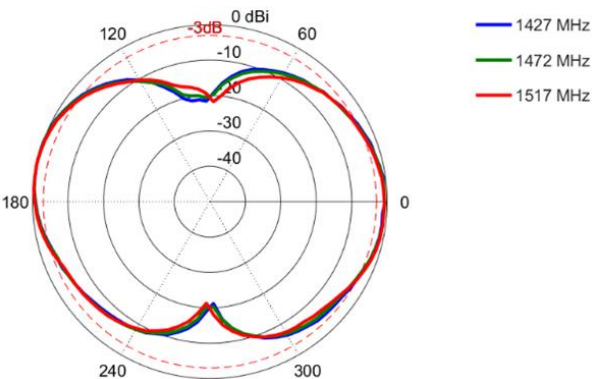

Azimuth: 1710 – 2170 MHz

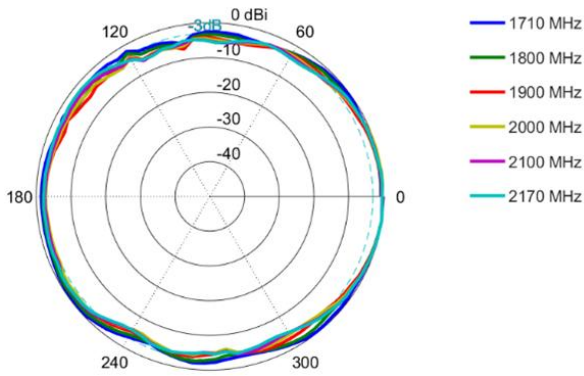

Elevation: 1710 – 2170 MHz

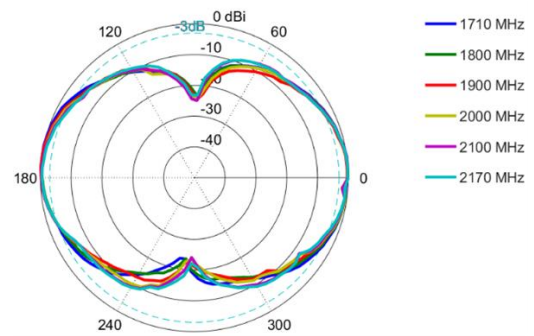

Azimuth: 2300 – 2700 MHz

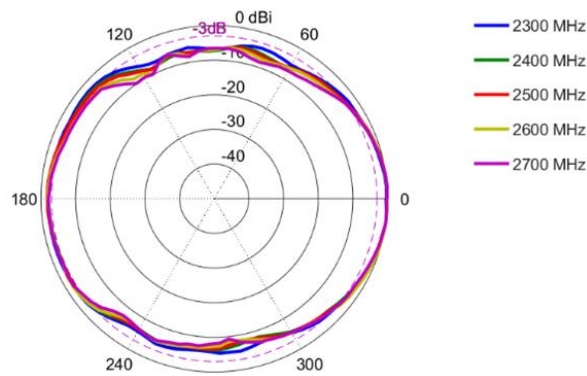

Elevation: 2300 – 2700 MHz

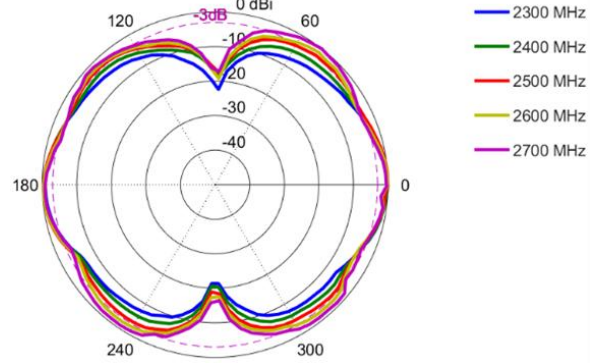

Azimuth: 3400 – 4200 MHz

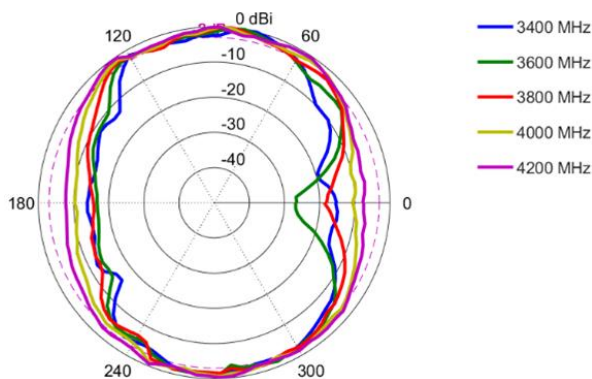

Elevation: 3400 – 4200 MHz

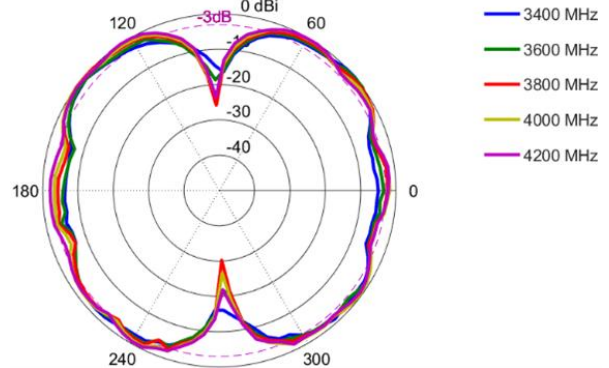

Azimuth: 5000 – 6000 MHz

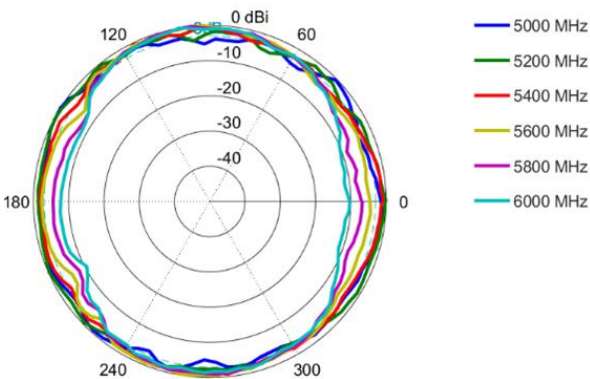

Elevation: 5000 – 6000 MHz

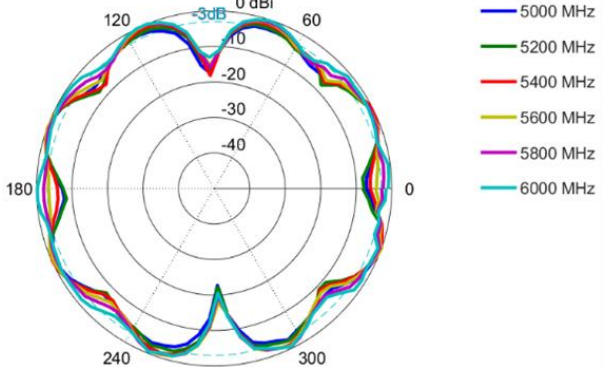

Radiation Patterns - WI-FI

Azimuth: 2400 - 2500 MHz

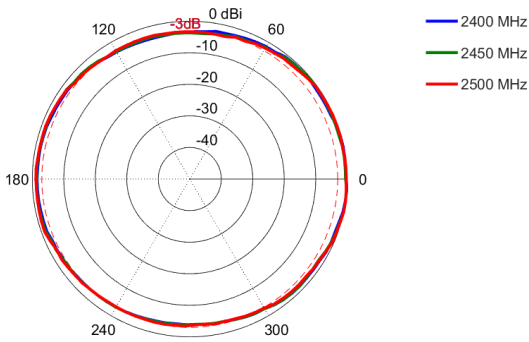

Elevation: 2400 - 2500 MHz

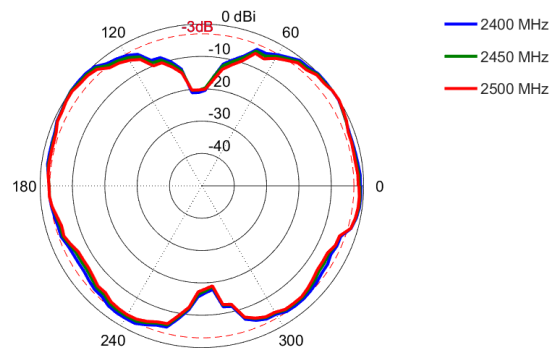

Azimuth: 5000 - 6000 MHz

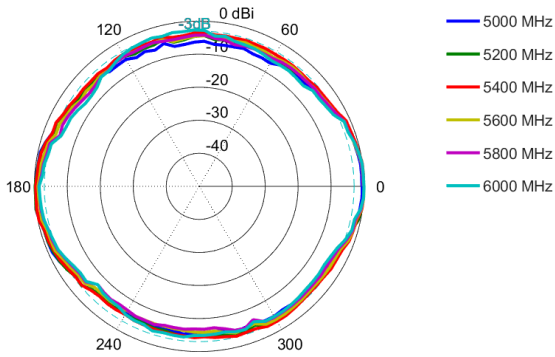

Elevation: 5000 - 6000 MHz

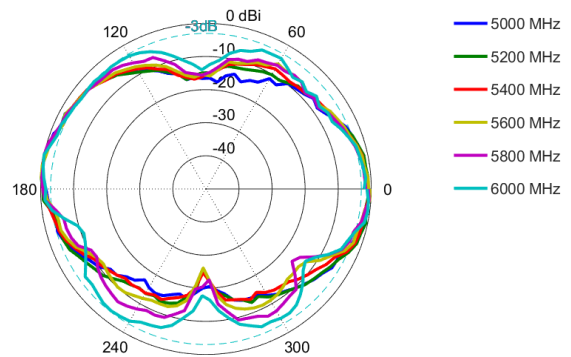

Azimuth: 6000 - 7200 MHz

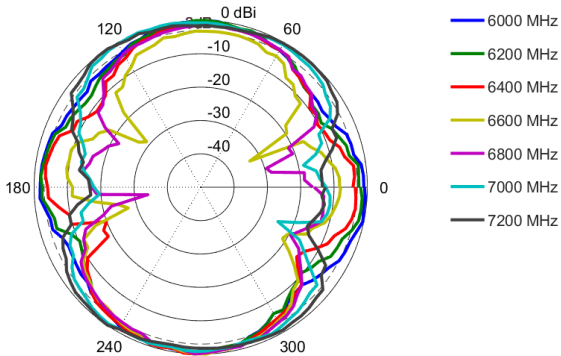

Elevation: 6000 - 7200 MHz

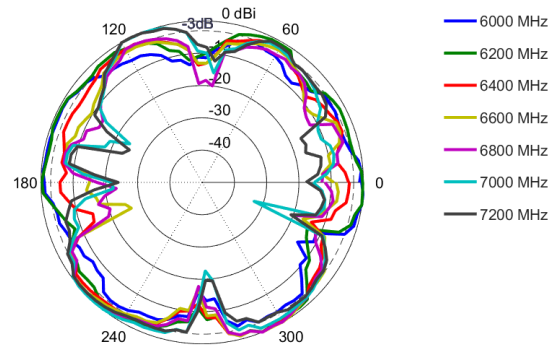

Technical Drawings

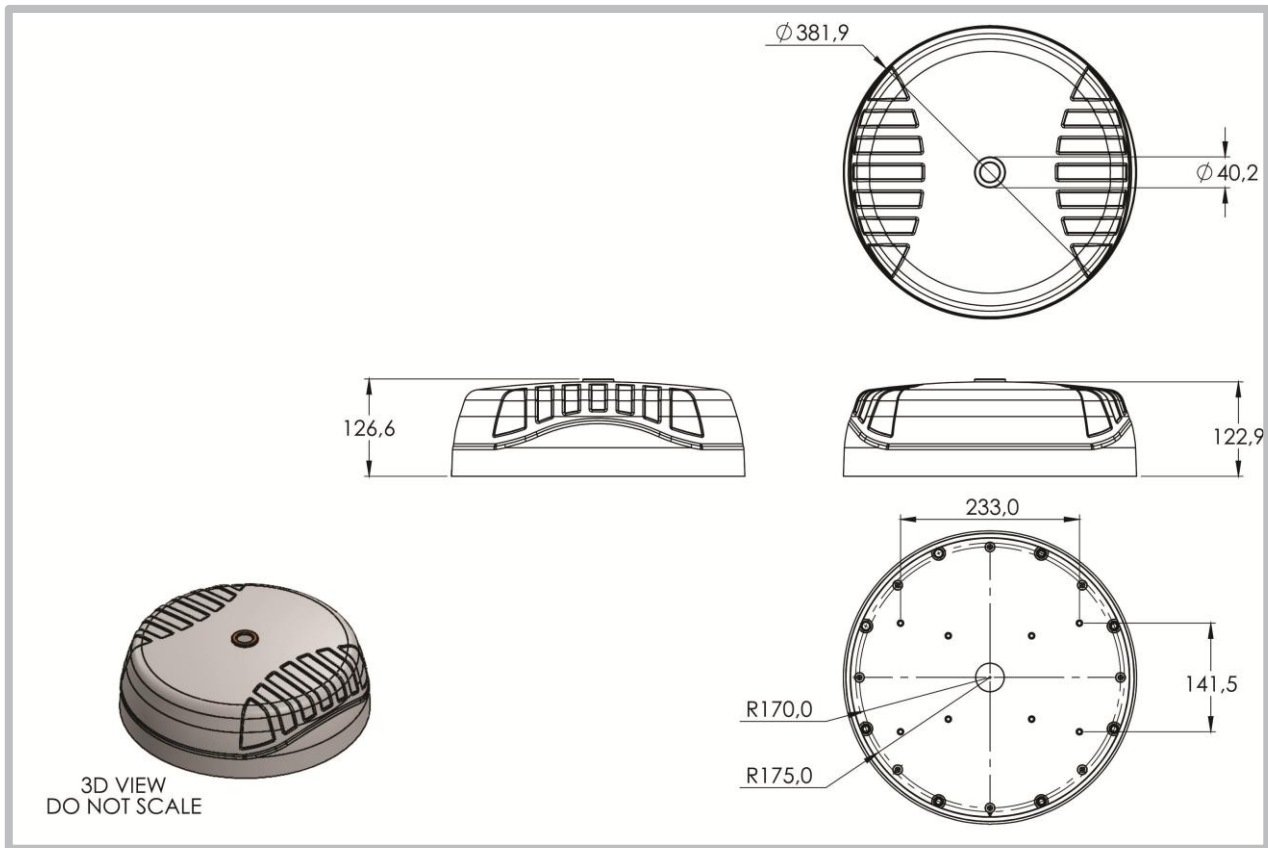

Mounting Options

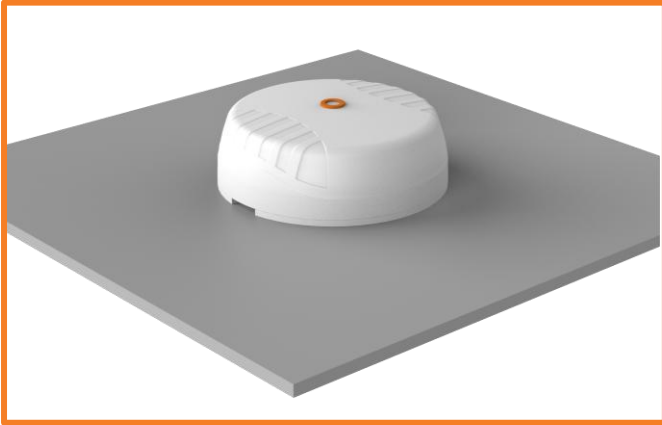

Surface Mount

Adhesive surface mounting (included) to directly secure the antenna to a surface.



Magnet mount

Magnetic Base Kit (MBK-5 not included)
For temporary and low-mobility installations.

MBK-5 Description:

Gripper Magnet M6 66x8.5 mm, M6 Thread Neodymium Magnet set.
Qty 4 (SWIRL Antenna)

Additional Accessories



CAB-119-7-RP 3m Cable Assembly (Optional)

(SWIRL-4)

One end: 5 x SMA (Female) - for Cellular & GPS and 2 x RP-SMA (Female) - for Wi-Fi connectors

Other end: 5 x SMA (Male) - for Cellular & GPS and 2 x RP-SMA (Male) - for Wi-Fi connectors.



CAB-119-13-RP 3m Cable Assembly (Optional)

(SWIRL-8)

One end: 9 x SMA (Female) - for Cellular & GPS and 4 x RP-SMA (Female) - for Wi-Fi connectors

Other end: 9 x SMA (Male) - for Cellular & GPS and 4 x RP-SMA (Male) - for Wi-Fi connectors.

See accessories technical specifications on www.poynting.tech

CONTACT POYNTING

Poynting Antennas (Pty) Ltd - Head Office

Unit 4, N1 Industrial Park,
Landmarks Avenue,
Samrand, 0157, South Africa

Phone: +27 (0) 12 657 0050

E-mail: info@poynting.tech

International Email: sales-global@poynting.tech

Poynting Europe

Regus Business Center Neue Messe Riem
Kronstadter Straße 4
81677 München
Germany

Phone: +49 89 7453 9002

E-mail: sales-europe@poynting.tech

Poynting USA

1804 Owen Court, Suite 104,
Mansfield,
TX 76063
USA

Phone: +1 817 533-8130

E-mail: sales-us@poynting.tech